

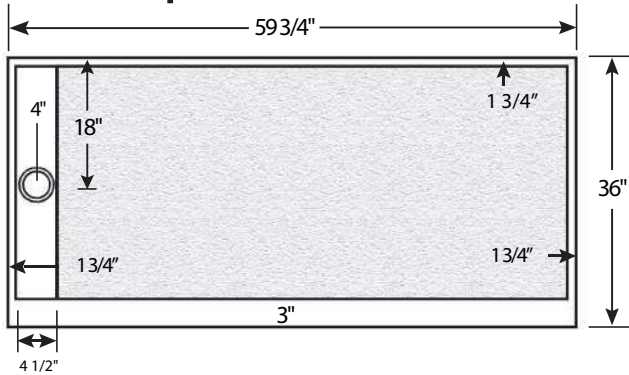

# Solid Surface 60" x 36" - 4" Trench Drain LH or RH Shower Base

TECHNICAL SPECIFICATIONS

**Top View - Left Drain**



**Front View - Left Drain**

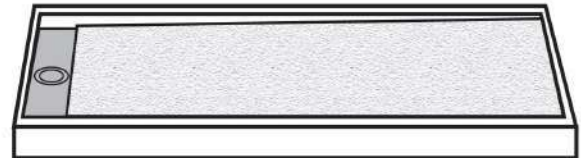

**Top View - Right Drain**

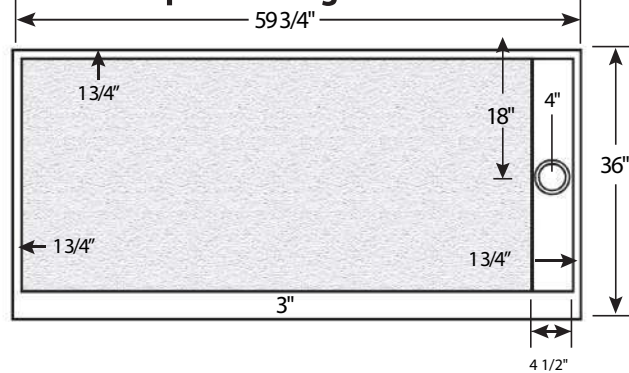

**Front View - Right Drain**

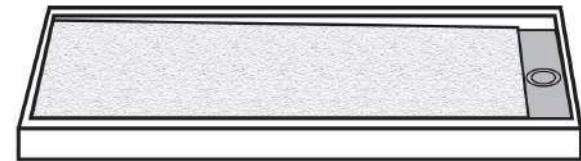

## Standard Features:

- Solid one-piece construction, non-porous through body
- Solid Surface Construction, contains minimum 60% solid particle aggregate aluminum hydroxide
- 40% Acrylic modified Polyester Resin
- Pre-leveled - rests on subfloor

## Specifications:

- Size: 60"x36" Size
- Flange: Integral
- Slip-Resistance: SCoF = 0.6+, wet; DCof=0.42+
- Breaking Strength: 250 lbs. Minimum
- Trench: 4 1/2" width

## Suggested Drains:

- Solvent Weld type fitting similar to Oatey Part No. 42097
- Compression type "No-Caulk" fitting similar to Oatey Part No. 42099

**Drain Details: (U.S.)**

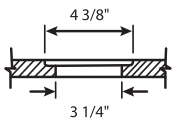

**Side View of Curb**

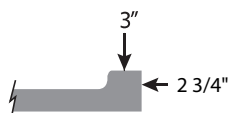

**Drain Cover**



**Note: Base dimensions may vary +/- 1/8"**

Our products comply with one or more of the following: IAPMO, ANSI, HUD, NAHB, NHQ

22 42 23 (Div 22)

Revised: 2020.01.24

© 2020 Copyright IMI International Marble Industries, Inc.